

CLARKE®



BELT & DISC SANDER

MODEL NO: CS6-9D

PART NO: 6500421

OPERATION & MAINTENANCE INSTRUCTIONS

UK
CA | CE



ORIGINAL INSTRUCTIONS

DL0224 - Rev 1

INTRODUCTION

Thank you for purchasing this CLARKE Belt and Disc Sander. The CS6-9D is designed for workshop use and comprises a 9" diameter sanding disc and a 6" wide sanding belt.

This machine is designed for sanding WOOD ONLY. DO NOT USE for sanding asbestos or materials containing asbestos, painted surfaces, or materials which produce toxic dust. Do not use for sanding magnesium as this produces a highly flammable dust.

Before attempting to use this product, please read this manual thoroughly and follow the instructions carefully. In doing so you will ensure the safety of yourself and that of others around you and you can look forward to your purchase giving you long and satisfactory service.

GUARANTEE

This product is guaranteed against faulty manufacture for a period of 12 months from the date of purchase. Please keep your receipt which will be required as proof of purchase.

This guarantee is invalid if the product is found to have been abused or tampered with in any way, or not used for the purpose for which it was intended.

Faulty goods should be returned to their place of purchase, no product can be returned to us without prior permission.

This guarantee does not effect your statutory rights.

ENVIRONMENTAL RECYCLING POLICY



By purchasing this product, the customer is taking on the obligation to deal with its safe disposal in accordance with the Waste Electrical and Electronic Equipment (WEEE).

In effect, this means that this product must not be disposed of with general household waste. It must be disposed of according to the laws governing Waste Electrical and Electronic Equipment (WEEE) at a recognised disposal facility.

If disposing of this product or any damaged components, do not dispose of with general waste. This product contains valuable raw materials. Metal products should be taken to your local civic amenity site for recycling of metal products.

SPECIFICATIONS

Model no	CS6-9D
Part no	6500421
Rated Voltage	230V ~ 50Hz
Power output	1.5 HP/1.1kW
Rated input wattage	1100W
Rated input ampere	4.8 A
Duty cycle	S1 (continuous)
IP rating	IPX0
Electrical insulation class	Class 1
Fuse rating	13A
Disc Speed	1500 rpm
Sanding belt speed	5.8 m/s
Sound Pressure Level LpA	78.4 dB(A), Uncertainty Factor (K) 3 dB(A)
Sound Power Level LWA	91.4 dB(A), Uncertainty Factor (K) 3 dB(A)
Vibration	Less than 2.5 m/s ² Uncertainty Factor (K) 1.5m/s ²
Dimensions (L x W x H)	Sander - 720 mm x 520 mm x 980 mm
Dimensions (L x W x H)	Stand - 425 mm x 385 mm x 575 mm
Weight	40 kg
Dust extract port size	50.8 mm (2")
Sanding belt size	152 mm x 1219 mm
Sanding disc size	228 mm dia (9")
Sanding table size	300 x 150 mm
Tilt angle	0-45°
Mitre gauge adjustment	-60° - +60°

POWER TOOL SAFETY WARNINGS

WORK AREA

1. **Keep the work area clean and well lit.** Cluttered and dark areas invite accidents.
2. **Do not operate power tools in explosive atmospheres, such as in the presence of flammable liquids or gases.** Power tools create sparks which may ignite the dust or fumes.
3. **Keep children and bystanders away while operating a power tool.** Distractions can cause you to lose control.

ELECTRICAL SAFETY

1. **Power tool plugs must match the outlet. Never modify the plug in any way. Do not use adaptor plugs with earthed (grounded) power tools.** Unmodified plugs and matching outlets will reduce the risk of electric shock.
2. **Do not expose power tools to rain or wet conditions.** Water entering a power tool will increase the risk of electric shock.
3. **Do not abuse the cable.** Never use it for carrying, pulling or unplugging the power tool. Keep the cable away from heat, oil, sharp edges or moving parts. Damaged or entangled cables increase the risk of electric shock.
4. **When operating a power tool outdoors, use an extension cable suitable for outdoor use.** Use of a cable suitable for outdoor use reduces the risk of electric shock.
5. **If operating the power tool in a damp location is unavoidable, use a residual current device (RCD) protected supply.**

PERSONAL SAFETY

1. **Stay alert,** watch what you are doing and use common sense when operating a power tool. Do not use a power tool while you are tired or under the influence of drugs, alcohol or medication. A moment of inattention while operating power tools may result in personal injury.
2. **Use safety equipment. Always wear eye protection.** Safety equipment such as dust mask, non-skid safety shoes, hard hat, or hearing protection used for appropriate conditions will reduce personal injuries.
3. **Avoid accidental starting.** Ensure the switch is in the off position before plugging in. Carrying power tools with your finger on the switch or plugging in power tools that have the switch on invites accidents.
4. **Do not overreach.** Keep proper footing and balance at all times. This enables better control of the power tool in unexpected situations.

5. **Dress properly.** Do not wear loose clothing or jewellery. Keep your hair, clothing and gloves away from moving parts. Loose clothes, jewellery or long hair can be caught in moving parts.

POWER TOOL USE AND CARE

1. **Do not force the power tool.** Use the correct accessories for your application. The correct power tool will do the job better and safer at the rate which it was designed for.
2. **Do not use the power tool if the switch does not turn it on and off.** Any power tool that cannot be controlled with the switch is dangerous and must be repaired.
3. **Disconnect the plug from the power source before changing accessories, or storing power tools.** Such preventive safety measures reduce the risk of starting the power tool accidentally.
4. **Store idle tools out of the reach of children and do not allow persons unfamiliar with the power tool or these instructions to operate it.** Power tools are dangerous in the hands of untrained users.
5. **Maintain power tools.** Check for misalignment or binding of moving parts, breakage of parts and any other condition that may affect the power tool's operation. If damaged, have the power tool repaired before use. Many accidents are caused by poorly maintained power tools.
6. **Use the power tool and accessories in accordance with these instructions and in the manner intended, taking into account the working conditions and the work to be performed.** Use of the power tool for operations different from intended could result in a hazardous situation.
7. The performance of this tool may vary, depending upon variations in line voltage. Extension cable usage may also affect performance.

SERVICING

1. **Have your power tool serviced by qualified service personnel using only identical replacement parts.** This will ensure that the safety of the power tool is maintained.

ADDITIONAL SAFETY WARNINGS FOR SANDERS

1. **Dust arising from sanding may endanger the health of the operator and possible bystanders.** Wear a dust mask and ensure that persons entering the work area are also protected.
2. Remove all dust after sanding.
3. Avoid sanding lead based paint, wood or metal which may produce toxic dust, - do not let children or pregnant women enter the work area.

ELECTRICAL CONNECTIONS



WARNING: READ THESE ELECTRICAL SAFETY INSTRUCTIONS FULLY BEFORE CONNECTING THE PRODUCT TO THE MAINS SUPPLY.

This product is provided with a standard, 230 volt (50Hz), BS 1363 plug, for connection to a standard, domestic electrical supply. Should the plug need changing, make sure that a plug of identical specification is used.



**WARNING: THE WIRES IN THE CABLE ARE COLOURED AS FOLLOWS:
BLUE = NEUTRAL BROWN = LIVE YELLOW AND GREEN = EARTH**

If the colours of the wires in the power cable do not correspond with the markings on the terminals of your plug, proceed as follows.

- Connect the **blue** wire to the terminal marked **N**.
- Connect the **brown** wire to the terminal marked **L**.
- Connect the **yellow and green** wire to the terminal marked **E** or .

Plug must be BS1363/A approved.

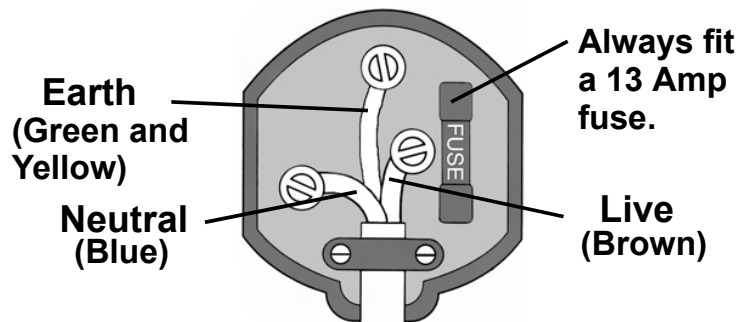

Ensure that the outer sheath of the cable is firmly held by the clamp

AN APPROVED RESIDUAL CURRENT DEVICE (RCD) WHICH HAS A TRIPPING CURRENT OF LESS THAN 30MA MUST BE USED.

If you are not sure, consult a qualified electrician. DO NOT try to do any repairs.

EXPLANATION OF SYMBOLS & PICTOGRAMS



Read instruction manual before use.



Wear safety glasses or goggles when using the tool.



Wear ear protection when using this tool.



Wear a dust mask.



Wear protective gloves.

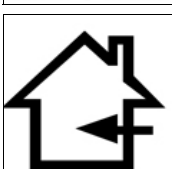

For indoor use only

INVENTORY

The CS69D sander is supplied with the following items which will require assembly.

- Stand assembly kit, comprising: - 2 x side panels, 2 x short cross members, 2 x long cross members, 4 x rubber feet with flat washers & nuts, 12 x M8 coach bolts /12 x M8 plain washers/12 x M8 nuts.
- 1 x Hex wrench (long)
- 1 x Spanner (10-13mm)
- 1 x Workstop
- 1 x Drive housing
- 1 x Sanding face plate
- 1 x Drive cover c/w fixing screws
- 1 x Small (motor) pulley
- 1 x Large (driven) pulley
- 1 x Drive belt
- 1 x Work table assembly
- 1 x Table support rod
- 1 x Mitre fence assembly
- 1 Fixing kit containing, grub screws, parallel keys, 4 x bolts, 4 x spring washers, 4 x large washers (sander to stand fixings), workstop retaining bolt/washer.
- 1 x Abrasive disc
- 1 x Abrasive belt

BEFORE USE

ASSEMBLING THE STAND

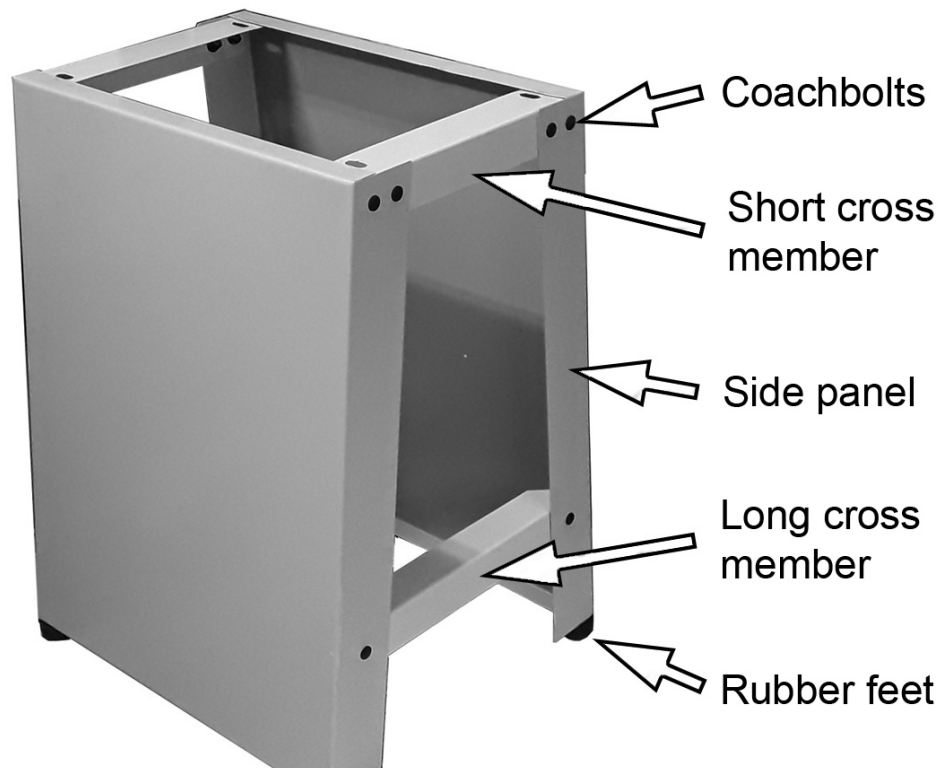

Assemble the stand as shown. The upper and lower beams are secured with the 12 x M8 coachbolts with flat washers & nuts. Add the rubber feet securing them with flat washers & nuts.

Do not tighten the nuts until all bolts are in place and the stand is rocked to ensure it is stable and evenly assembled. When satisfied, tighten securely.

WITH ASSISTANCE, considering its weight, place the sander on top of the stand. Position it so that the bolt holes, viewed from below, line up. Enter the 13mm bolts fitted with flat and lock washers and tighten securely from below.

FITTING THE DRIVE COMPONENTS

1. Fit the drive housing to the frame using 4 x M8 x12 retaining bolts and flat washers.

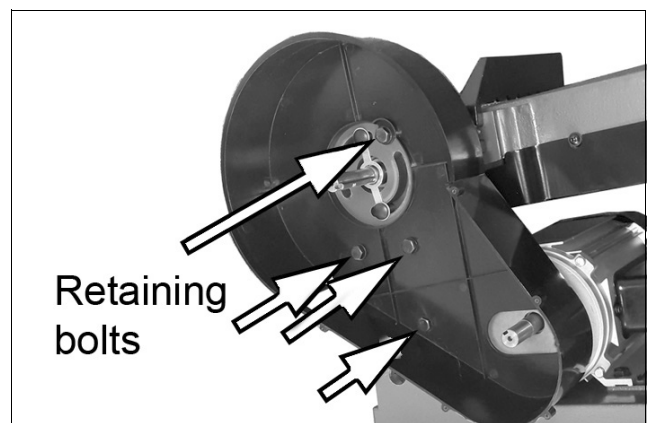

2. Slide the 5 x 55 mm parallel key into the groove in the shaft and slide driven pulley onto the end of the driven shaft, engaging with the key.

3. Pass the drive belt over both pulleys and slide the motor pulley onto the motor shaft complete with the 5 x 25 mm parallel key.

4. Press both pulleys onto the shafts as far as they will go. This will ensure that they are correctly aligned.

5. Using the hex wrench supplied, tighten the M8 x 10 setscrews to secure the both pulleys.

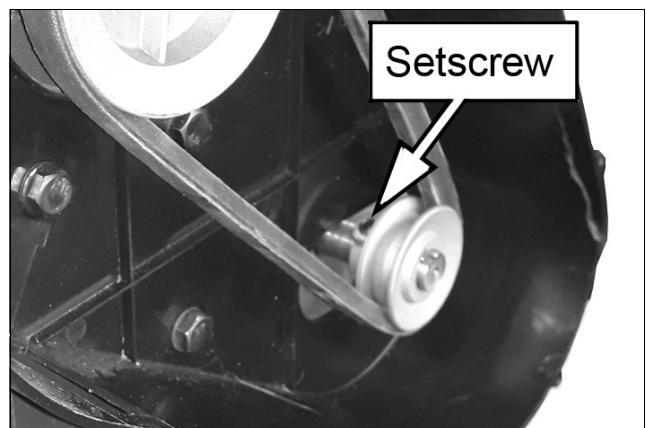
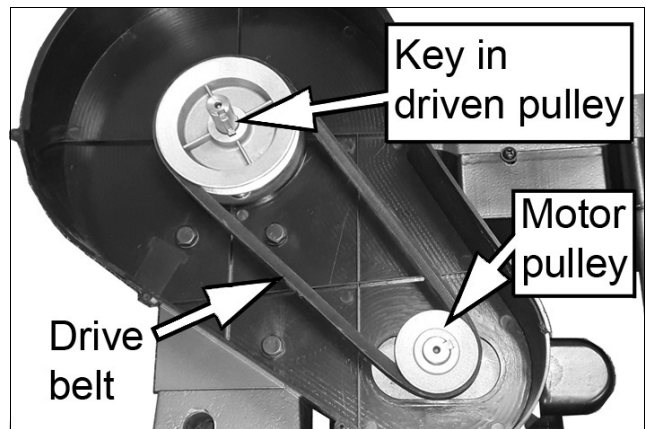

6. Tension the drive belt as necessary by adjusting the position of the motor on the bedplate using the 4 adjusting bolts.

- As a rough guide, aim for approx 12mm deflection at the mid-point of the drive belt and confirm there is no slippage of the belt on the pulleys.

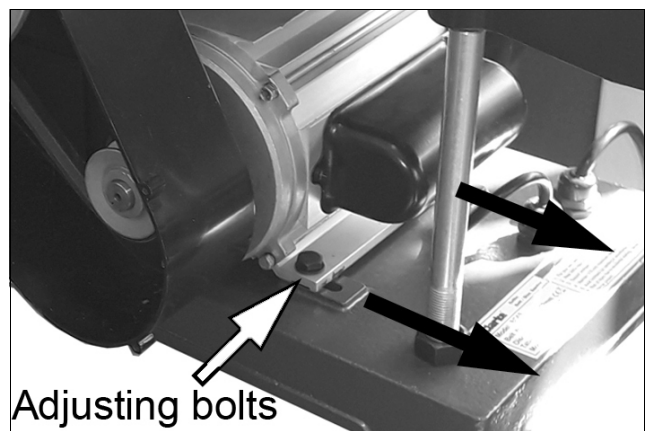

7. Slide the face plate onto the driven shaft, engaging with the parallel key already in position.

8. Use the hex wrench supplied to tighten the setscrew and secure the face plate to the driven shaft, inserting the wrench through the access slot in the drive cover.

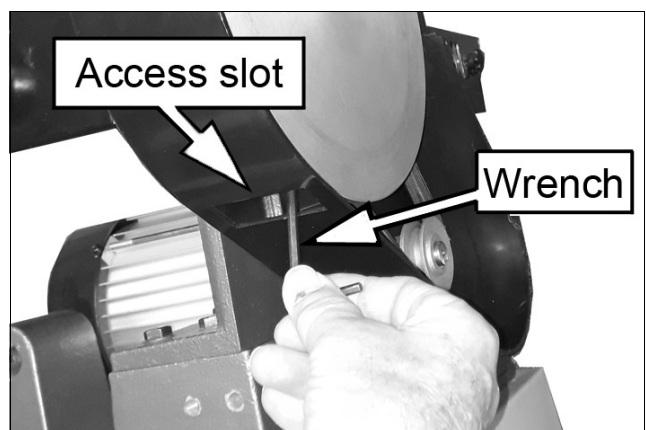

9. Check that the surface of the face plate is clean and attach the abrasive disc after peeling off the backing material. Take great care to position it centrally.



10. Fit the drive cover using the self-tapping screws.

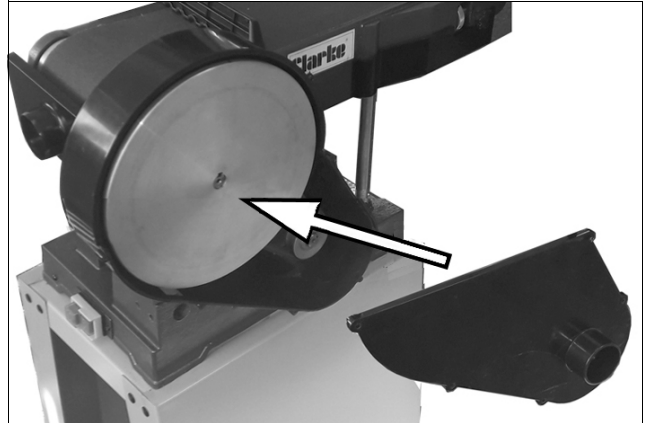

Fit the work stop to the frame using the M8 x 20 bolt and flat washer.

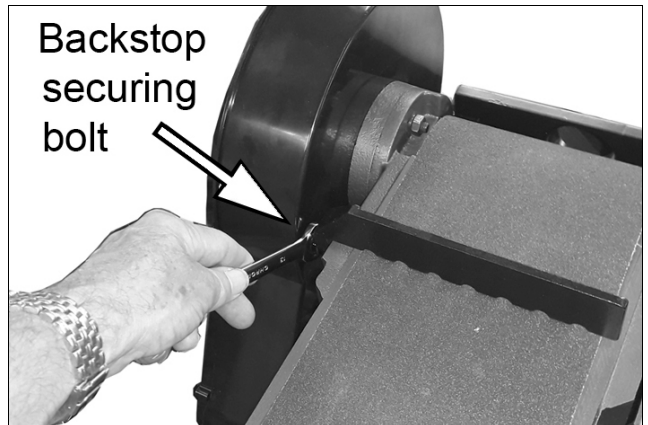

CHECKS BEFORE USE

As with all machinery, it is important to ensure that the various components are properly secure and in good order before use.

The sander is designed so that when switched ON, both the belt AND the disc will rotate. It is also important therefore, to ensure that the belt runs true on the rollers, referred to as 'Tracking'. Although the necessary adjustments have been carried out at the factory, it is nevertheless prudent to perform this check when first setting up your machine in the event it has been disturbed during transit.

CHECKING THE BELT TRACKING

The rollers must run parallel, otherwise the belt will be driven off to one side.

1. Plug in to the mains supply and press the GREEN ON button, marked 'I' to start the machine, keeping well away from the belt.
2. Observe the belt for a short period as it passes over the front roller...there should be no creep to one side. If it does creep, switch OFF by pressing the RED OFF button, marked 'O'.

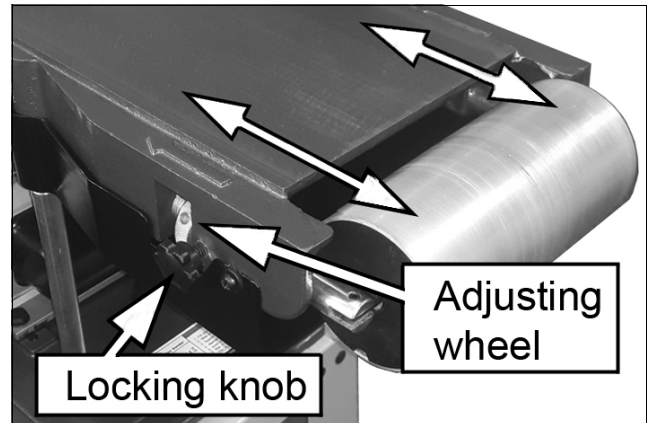

To perform the adjustment, release the locking knob on each side of the machine and turn the adjusting wheel to either slacken or tension one side of the abrasive belt. Note that only small adjustments should be required.

3. Restart the machine and screw the adjusting wheels very gently in or out to compensate for the creep. When the belt is running true, switch off and tighten the locking knobs. When satisfied, restart and check the tracking is now correct. If necessary, repeat until the belt runs true.

FITTING THE WORK TABLE FOR USE WITH THE DISC

The mounting of the work table will depend upon the job in hand, i.e. either adjacent to the disc or to the belt.

The table is mounted on a support bar which is inserted into the housing on the machine base and secured with 2 x M8x20 setscrews.

1. Tighten the securing setscrews to secure the support bar in the base.
2. Slide the table assembly on to the support bar and bring the table to within 2mm of the sanding disc. Tighten the securing setscrew in the table frame to secure it to the support rod.

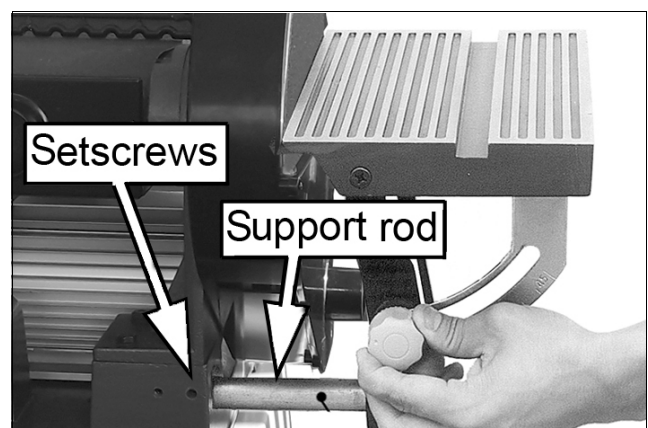

- To ensure the table is at exactly 90° to the sanding disc, position a small engineers set square on the table so that it touches the disc. Slacken off the table angle adjustment knob, shown and adjust accordingly so that the table sits level.
- Tighten the adjustment knob and if necessary, zero the pointer adjacent to the scale by slackening the securing screw and repositioning.

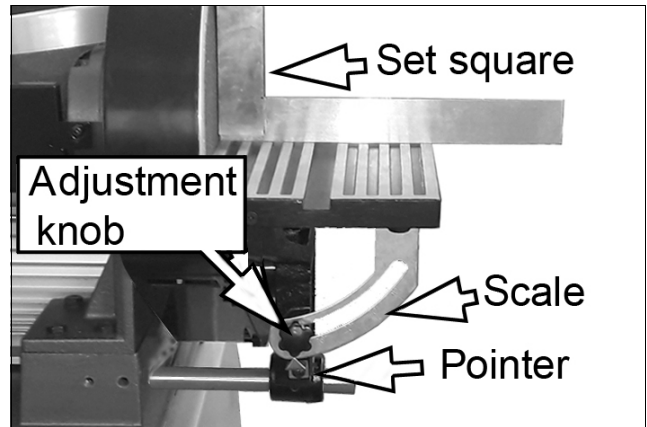

FITTING THE WORK TABLE FOR USE WITH THE BELT

- When using the work table with the sanding belt in the upright position, remove the work stop from the belt frame by removing the workstop securing bolt.
- Before attaching the table to the mounting, raise the sanding belt arm and secure in position using the locking bolt shown. An open spanner is provided for this.
- Slide the table support rod into the mounting as shown and tighten the two securing setscrews.
- Mount the table on the support bar, bring to within 2 mm of the belt and tighten the securing setscrew. Ensure the table is level.
- To ensure the belt is perpendicular to the table, use an engineers square as described above, adjusting the angle of the sanding belt arm using the arm locking bolt shown.
- Ensure the work stop is replaced correctly when returning the belt to the horizontal position.

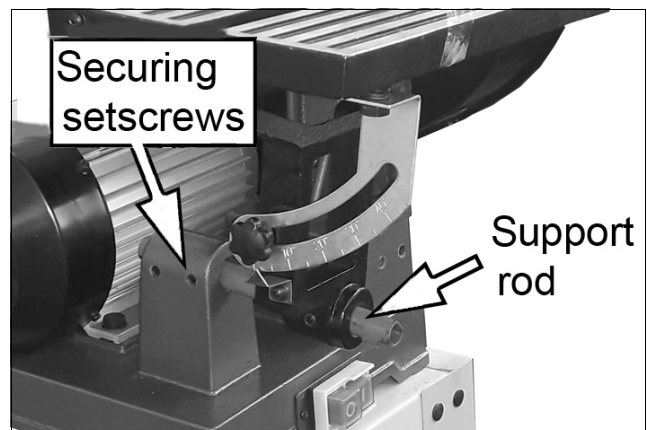
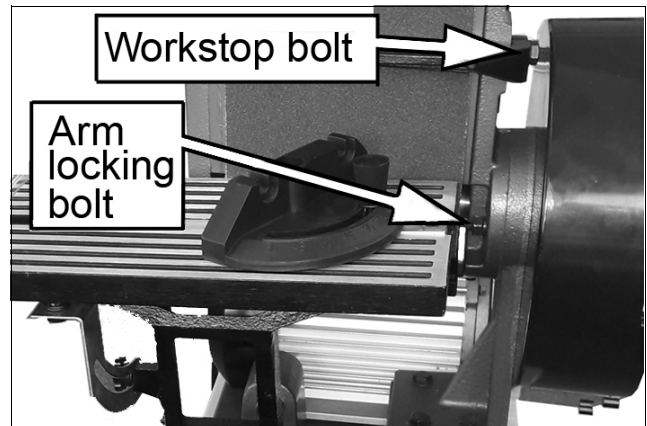

METHOD OF USE

USING THE DISC

1. Check that the table is approximately 2mm from the sanding disc before switching on.
2. Hold the work firmly as shown and ALWAYS hold the workpiece against the left half of the disc. i.e. that half moving downwards towards the sanding table.
3. DO NOT exert too much pressure. A light touch is all that is required.
 - The photo shows the table being used in conjunction with the mitre gauge.
4. Set the gauge to the angle you require and hold the workpiece firmly against the gauge, feeding it gently against the sanding disc.
5. Keep the workpiece in contact with the left side of the disc as far as possible.
 - The illustration shows the sanding table set to an angle. The mitre gauge may also be used with this setup.
 - Angles up to 45° may be set.
6. If accuracy is required, check the angle using a suitable square or template.

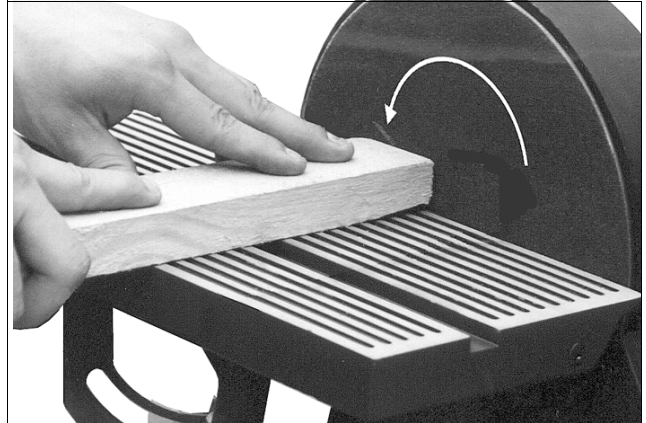

USING THE BELT

The work stop must be in place when using the belt horizontally.

1. Secure using the bolt and flat washer as shown.
2. Ensure a gap of no more than 2mm exists between the belt and the work stop.
3. The belt can be used in the vertical position as shown. In this case, the work stop should be removed. Lock the belt frame in the upright position using the arm locking bolt shown on page 13.

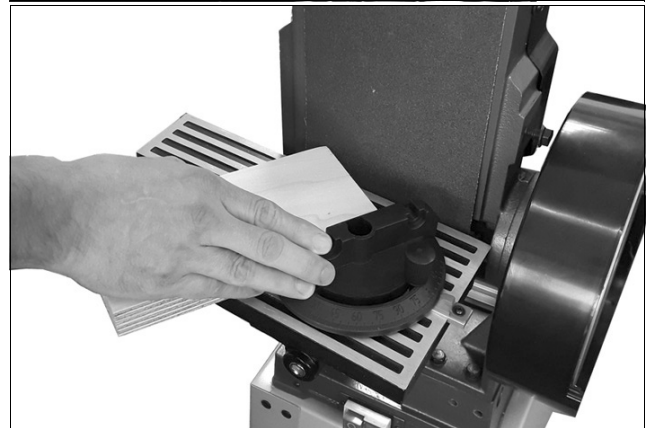

The belt is used for long workpieces, as shown. The workpiece is driven against the work stop by the action of the belt.

- DO NOT exert too much pressure - a light touch is all that is required.
 - Curves may be sanded as shown.
4. Let the sander do the work and ensure the workpiece is flat on the table surface. Never apply heavy pressure as this will not only produce an uneven finish but will overload the motor causing it to burn out.
 5. On very uneven surfaces or when removing layers of paint, start with a coarse grit. On other surfaces, start with a medium grit. In both cases, gradually change to a fine grit for a smooth finish. Regularly check the condition of the sanding belt or disc and replace it when necessary.

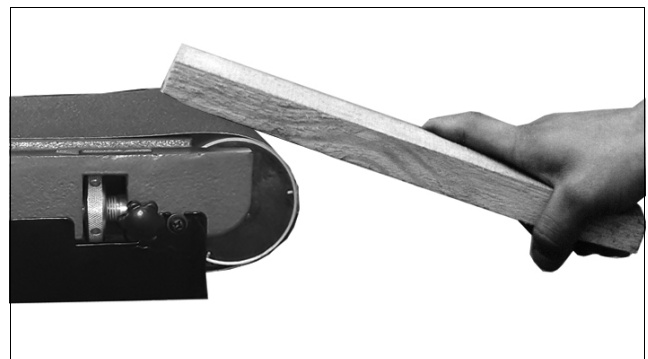

DUST EXTRACTION



WARNING: HARMFUL OR TOXIC DUST MAY BE PRODUCED WHEN SANDING LEAD PAINTED SURFACES, WOODS OR METAL. CONTACT WITH, OR INHALATION OF THESE DUSTS CAN ENDANGER THE HEALTH OF THE OPERATOR OR BYSTANDERS. CERTAIN DUSTS LIKE OAK AND BEECH ARE CONSIDERED TO BE CANCEROUS IN CONJUNCTION WITH ADDITIVES IN WOOD TREATMENTS (CHROMATE, WOOD PRESERVATIVES). ASBESTOS-CONTAINING MATERIALS MAY ONLY BE HANDLED BY EXPERTS.

WARNING: - USE A DUST EXTRACTION DEVICE OR A VACUUM CLEANER.

WARNING: - WORK IN A WELL VENTILATED ROOM.

**WARNING: -THE USE OF A DUST MASK FILTER CLASS P2 IS RECOMMENDED.
- OBSERVE LOCAL REGULATIONS REGARDING THE HANDLING OF CERTAIN MATERIALS.**

Provision is made for dust extraction from both the disc and belt.

The dust extraction outlets are shown and have a diameter of 51 mm (2").

Connect a suitable hose to a vacuum cleaner via a reducer if required, or dust extraction device (see your CLARKE dealer).

NOTE: The user should still wear a face mask to prevent the inhalation of dust particles.

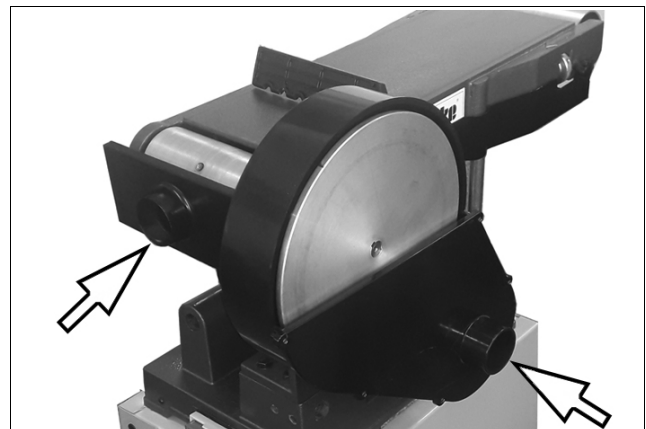

Due to the nature of the sander some of the dust produced will be forced into the surrounding atmosphere and will not be collected.

MAINTENANCE



WARNING: BEFORE PERFORMING ANY MAINTENANCE, SWITCH OFF AND UNPLUG THE SANDER.

Your sander will operate over a long period of time with a minimum of maintenance. Continuous satisfactory operation depends upon proper care.

Regularly clean the motor ventilation slots using a soft dry brush, cloth or vacuum cleaner and remove undue buildup of dust from the sander. Do not use any abrasive or solvent-based cleaner.

A damaged power cable should be replaced by your CLARKE dealer or qualified electrician.

The bearings in this sander are sealed for life and require no maintenance.

CHANGING THE BELT

1. Disconnect any dust extract hoses connected to the machine.
2. Remove the lower belt cover by slackening the six securing screws sufficiently for the cover to be slipped off the frame.
3. Tilt the frame assembly up in order that the belt cover remains away from the belt.
4. Lock the bed in the upright position using the locking nut.
5. Release the belt tension locking knobs and unscrew the belt adjusting wheels until the belt goes slack.

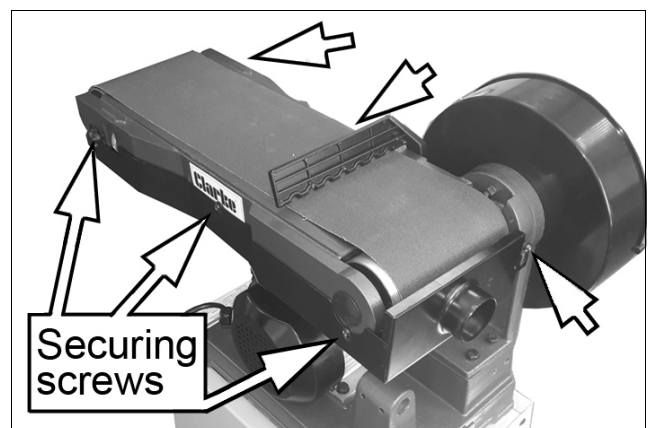

The belt may now be slipped off and replaced by a new one. Drop the frame back to the horizontal position and refit the belt guard/cover.

6. Tension the belt by the belt tension adjusting wheels.
7. Check the belt tracking as previously described on page 12.

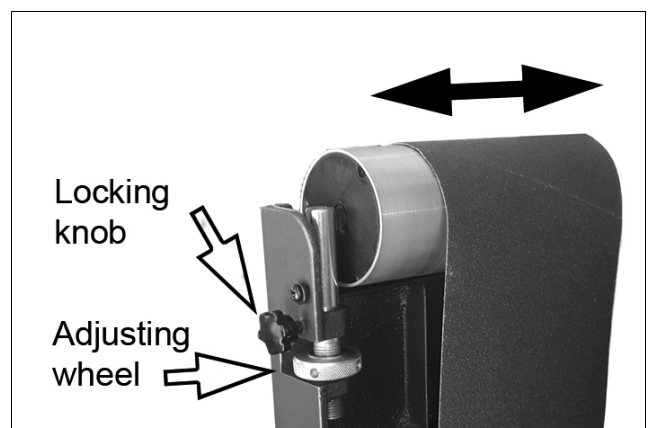

CHANGING THE DISC

1. Remove the screws and lift away the drive cover as shown then peel the abrasive disc from the faceplate.

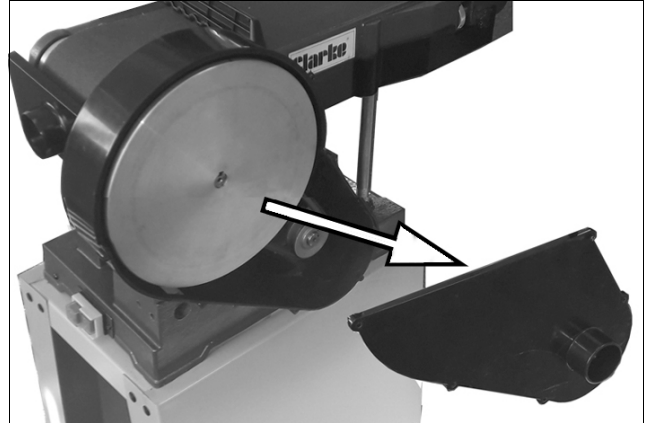

2. Clean any residual adhesive from the faceplate and refit a new abrasive disc, taking great care that it is central. Ensure it is evenly attached across its surface.
3. When satisfied, replace the drive cover.



FAULTFINDING

SANDER IS OVERHEATING

Overloading the machine will cause overheating. do not apply excessive pressure when working. The motor may over heat if covered in dust which can be blown out with compressed air. Always wear eye protection and a dust mask when using compressed air.

EXCESSIVE MOTOR SPARKING OCCURS

This indicates worn brushes. This problem is quickly remedied but you should consult your CLARKE dealer for parts and advice.

SANDER DOES NOT OPERATE WHEN SWITCHED ON

Check to ensure the fuse is sound and replace if necessary. If the fuse is sound or blows repeatedly, consult your CLARKE dealer.

POOR ABRASION

If the sander is not removing material efficiently, check the sanding sheet. If the abrasive is worn down replace the sheet. The sanding sheet must always

be stored in a dry place as if it allowed to become damp, the abrasive particles will detach from the sheet and will not abrade.

POOR DRIVE

If the sander does not reach full speed or slows down during hard sanding, the main drive belt may be slipping. Tension the belt by means of the adjusting bolts shown on page 10.

ACCESSORIES

Replacement discs and belts are available in packs of 5 from your CLARKE dealer.

Please quote the part numbers below.

6" Replacement belts (150 x 1219mm)	Part Number
Fine	6502098
Medium	6501164
Coarse	6502103
Replacement 9" discs	Part Number
Fine	6502099
Medium	6501076
Coarse	6502100

PARTS DIAGRAM

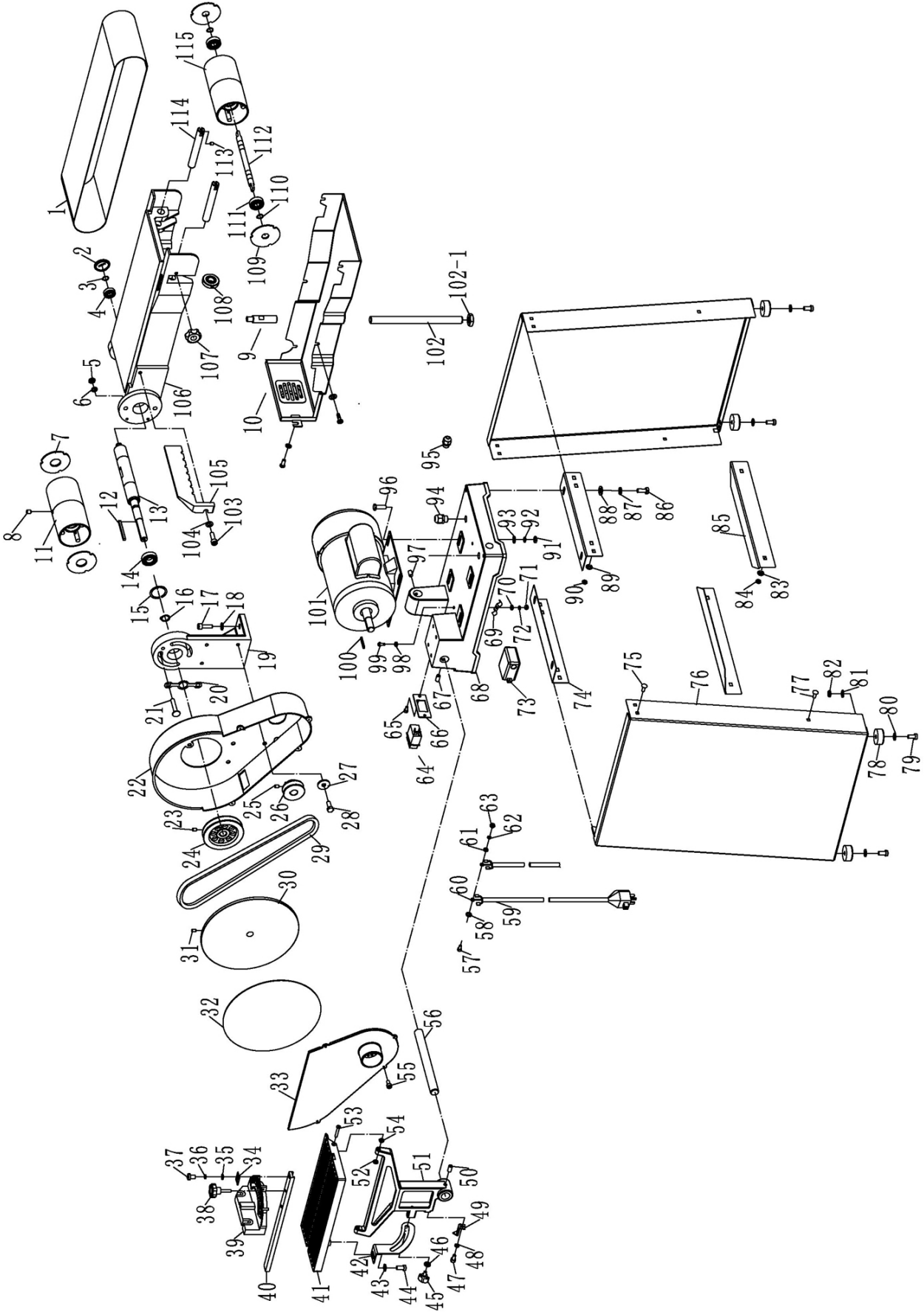

PARTS LIST

No	Description
1	Abrasive belt
2	Bearing cover
3	Circlip
4	Bearing
5	M8 nut
6	Lock washer
7	Drum cover
8	M8x10 set screw
9	Connecting rod
10	Abrasive belt guard
11	Drive drum
12	5 x 55 mm key
13	Drive shaft
14	Bearing
15	Washer
16	Circlip
17	M8 x bolt
18	8mm flat washer
19	Bracket
20	Spacer plate
21	M8 x 40 carriage bolt
22	Belt housing
23	M8 x 10 set screw
24	Driven pulley
25	M8 x 10 set screw
26	Motor pulley
27	8mm washer
28	M8 x 12 bolt
29	V-belt
30	Aluminium disc

No	Description
31	M8 x 10 set screw
32	Abrasive disc
33	Disc cover
34	Pointer
35	4mm flat washer
36	4mm lock washer
37	M4 x 5 pan head screw
38	Lock knob
39	Mitre gauge
40	Guide bar
41	Table
42	Angle plate
43	8mm washer
44	M8 x 12 bolt
45	Locking knob
46	8mm flat washer
47	M5 x 40 flat head bolt
48	M5 hex nut
49	Pointer
50	M8 x 10 set screw
51	Table support
52	Nut
53	M5 x 40 flat head bolt
54	M5 hex nut
55	Self tapping screw
56	Support bar
57	M5 x 16 pan head screw
58	Washer
59	Power cable
60	Terminal

61	5mm flat washer
62	5mm lock washer
63	M5 hex nut
64	Switch
65	Self tapping screw
66	Switch plate
67	M8 x 20 set screw
68	Base
69	Cable clamp plate
70	5mm flat washer
71	M5 hex nut
72	5mm lock washer
73	Switch box
74	Top frame
75	M6 x 12 carriage bolt
76	Brace
77	M6 x 12 carriage bolt
78	Rubber foot
79	M8 x 25 socket head bolt
80	8mm flat washer
81	8mm flat washer
82	M8 nut
83	6mm flat washer
84	M6 nut
85	Leg
86	M8 x 16 bolt
87	8mm lock washer
88	8mm flat washer
89	6mm flat washer

90	M6 nut
91	M8 nut
92	8mm lock washer
93	8mm flat washer
94	Strain relief 1
95	Strain relief 2
96	M8 x 20 bolt
97	M8 x 10 setscrew
98	5mm flat washer
99	M5 x 20 pan head screw
100	5 x 25 key
101	Motor
102	Support rod
103	M8x20 bolt
104	8mm flat washer
105	Work stop
106	Belt frame
107	Lock knob
108	Tracking nut
109	Drum cover
110	Circlip
111	Bearing
112	Shaft
113	M5 x 6 setscrew
114	Adjusting nut
115	Idler drum
116	6mm flat washer
117	M6 x 10 pan head screw

DECLARATION OF CONFORMITY



Hennell Street, Epping, Essex, CM16 4LG

DECLARATION OF CONFORMITY

This is an important document and should be retained.

We hereby declare that this product(s) complies with the following legislation:

- The Electromagnetic Compatibility Regulations 2016
- The Supply of Machinery (Safety) Regulations 2008
- The Restriction of the Use of Certain Hazardous Substances in Electrical and Electronic Equipment Regulations 2012

The following standards have been applied to the product(s):

- EN IEC 61000-3-2:2019/A1:2021, EN 61000-3-3:2013/A2:2021, EN IEC 55014-1:2021,
- EN IEC 55014-2:2021, EN 62321-7-1:2015, EN 62841-1:2015, EN 62321-4:2014, EN 62321-5:2014,
- EN ISO 12100:2010, EN 62321-3-1:2014, EN 62321-7-2:2017, EN 62321-1:2013, EN 62321-2:2014,
- EN 62321-8:2017, EN 62321-6:2015

The technical documentation required to demonstrate that the product(s) meet(s) the requirement(s) of the aforementioned legislation has been compiled and is available for inspection by the relevant enforcement authorities.

The UKCA mark was first applied in: 2024

Product Description: Bell & Disc Sander
Model Number(s): CS69D
Serial/Batch Number: Refer to product/packageing label
Date of Issue: 06/02/2024

Signed:

J.A Clarke
Director

CS69D UKCA Clarke DOC 020624

Page 1 of 1



Fitzwilliam Hall, Fitzwilliam Place, Dublin 2

DECLARATION OF CONFORMITY

This is an important document and should be retained.

We hereby declare that this product(s) complies with the following legislation:

- 2014/30/EU Electromagnetic Compatibility Directive
- 2006/42/EC Machinery Directive
- 2011/65/EU Restriction of Hazardous Substances (RoHS) Directive

The following standards have been applied to the product(s):

- EN IEC 61000-3-2:2019/A1:2021, EN 61000-3-3:2013/A2:2021, EN IEC 55014-1:2021,
- EN IEC 55014-2:2021, EN 62321-7-1:2015, EN 62841-1:2015, EN 62321-4:2014, EN 62321-5:2014,
- EN ISO 12100:2010, EN 62321-3-1:2014, EN 62321-7-2:2017, EN 62321-1:2013, EN 62321-2:2014,
- EN 62321-8:2017, EN 62321-6:2015

The technical documentation required to demonstrate that the product(s) meet(s) the requirement(s) of the aforementioned legislation has been compiled and is available for inspection by the relevant enforcement authorities.

The CE mark was first applied in: 2020

Product Description: Bell & Disc Sander
Model Number(s): CS69D
Serial/Batch Number: Refer to product/packageing label
Date of Issue: 06/02/2024

Signed:

J.A Clarke
Director

CS69D CE Clarke DOC 020624

Page 1 of 1

A SELECTION FROM THE VAST RANGE OF

Clarke®

QUALITY PRODUCTS



AIR COMPRESSORS

From DIY to industrial, Plus air tools, spray guns and accessories.

GENERATORS

Prime duty or emergency standby for business, home and leisure.

POWER WASHERS

Hot and cold, electric and engine driven - we have what you need

WELDERS

Mig, Arc, Tig and Spot. From DIY to auto/industrial.

METALWORKING

Drills, grinders and saws for DIY and professional use.

WOODWORKING

Saws, sanders, lathes, mortisers and dust extraction.

HYDRAULICS

Cranes, body repair kits, transmission jacks for all types of workshop use.

WATER PUMPS

Submersible, electric and engine driven for DIY, agriculture and industry.

POWERTOOLS

Angle grinders, cordless drill sets, saws and sanders.

STARTERS/CHARGERS

All sizes for car and commercial use.

PARTS & SERVICE: 0208 988 7400

Parts Enquiries
Parts@clarkeinternational.com

Servicing & Technical Enquiries
Service@clarkeinternational.com

SALES: UK 01992 565333 or Export 00 44 (0)1992 565335

Clarke INTERNATIONAL Hemnall Street, Epping, Essex CM16 4LG
www.clarkeinternational.com